

## Tees

### Female

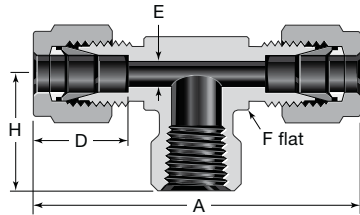

### Branch, NPT (TTF)

Tube OD	NPT Size in.	Basic Ordering Number	Dimensions				
			A	D	E	F, in.	H
<b>Dimensions, in.</b>							
1/8	1/8	-200-3TTF	1.94	0.50	0.09	1/2	0.75
1/4	1/8	-400-3TTF	2.12	0.60	0.19	1/2	0.75
	1/4	-400-3-4TTF	2.34			11/16	0.88
3/8	1/4	-600-3TTF	2.46	0.66	0.28	11/16	0.88
	3/8	-600-3-6TTF	2.62			13/16	0.88
	1/2	-600-3-8TTF	2.84			1	1.12
1/2	1/4	-810-3-4TTF	2.84	0.90	0.41	13/16	0.88
	3/8	-810-3TTF	2.84			13/16	0.88
	1/2	-810-3-8TTF	3.06			1	1.12
5/8	1/2	-1010-3TTF	3.06	0.96	0.50	1	1.12
3/4	3/4	-1210-3TTF	3.52	0.96	0.62	1 3/8	1.25
1	3/4	-1610-3-12TTF	3.86	1.23	0.88	1 3/8	1.25
	1	-1610-3TTF	4.22			1 11/16	1.50
<b>Dimensions, mm</b>							
6	1/8	-6M0-3TTF	53.9	15.3	4.8	1/2	19.0
	1/4	-6M0-3-4TTF	59.5			11/16	22.4
8	1/8	-8M0-3TTF	59.7	16.2	6.4	5/8	19.0
	1/4	-8M0-3-4TTF	61.2			11/16	22.4
10	1/4	-10M0-3TTF	67.0	17.2	7.9	13/16	22.4
12	1/4	-12M0-3-4TTF	72.0	22.8	9.5	13/16	22.4
	3/8	-12M0-3TTF	72.0			13/16	22.4
	1/2	-12M0-3-8TTF	77.7			1	28.4
16	1/2	-16M0-3TTF	77.6	24.4	12.7	1	28.4

## Cross

### Union

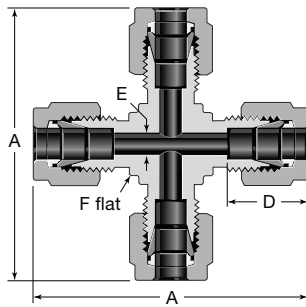

Tube OD	Basic Ordering Number	Dimensions			
		A	D	E	F, in.
<b>Dimensions, in.</b>					
1/8	-200-4	1.76	0.50	0.09	3/8
1/4	-400-4	2.12	0.60	0.19	1/2
5/16	-500-4	2.34	0.64	0.25	5/8
3/8	-600-4	2.40	0.66	0.28	5/8
1/2	-810-4	2.84	0.90	0.41	13/16
3/4	-1210-4	3.14	0.96	0.62	1 1/16
1	-1610-4	3.86	1.23	0.88	1 3/8
<b>Dimensions, mm</b>					
3	-3M0-4	44.7	12.9	2.4	3/8
6	-6M0-4	53.9	15.3	4.8	1/2
8	-8M0-4	59.7	16.2	6.4	5/8
10	-10M0-4	67.0	17.2	7.9	13/16
12	-12M0-4	72.0	22.8	9.5	13/16
16	-16M0-4	74.0	24.4	12.7	15/16
18	-18M0-4	76.6	24.4	15.1	1 1/16
20	-20M0-4	89.3	26.0	15.9	1 3/8
22	-22M0-4	89.4	26.0	18.3	5/8
25	-25M0-4	98.3	31.3	21.8	1 3/8

Refer to Installation Instructions, beginning on page 62.